

## Fitting Instructions

Please read these instructions carefully and check the contents of the pack against the table, before attempting to assemble and fix this product. The fixing screws supplied are for use where a wooden batten is fixed to the wall. If you intend to fix the track directly to the wall, you must use the most appropriate wall plugs and fixings.

Tools Required: Spirit level, Tape measure, Crosshead screwdriver, 2mm drill bit (pilot hole for wood screws), Pencil, Step ladder.

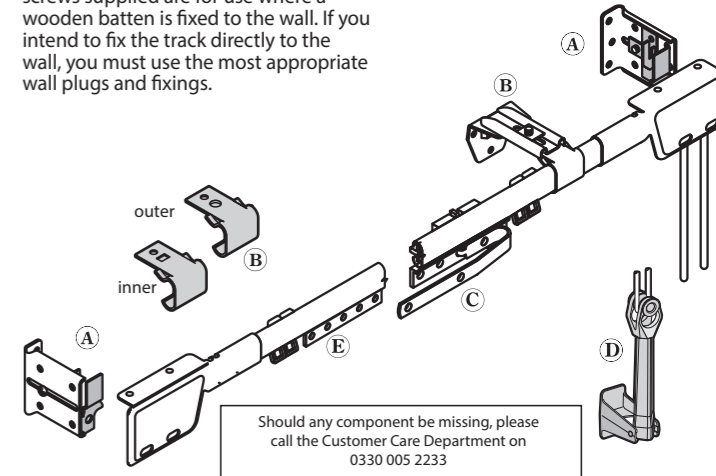

Should any component be missing, please call the Customer Care Department on 0330 005 2233

Contents ▼	Lengths ►	1.0m - 1.75m	1.75m - 3.0m	2.5m - 4.0m	3.0m - 5.5m
A Rail End Bracket		2	2	2	2
B Intermediate Bracket	inner	0	1	1	2
	outer	1	1	2	3
C Overlap Arm		1	1	1	1
D Tension Pulley		1	1	1	1
E Gliders		18	30	40	56

## WARNING

It is essential that these instructions are followed to ensure the product works correctly and to prevent the risk of young children becoming entangled in the cord loop. If in doubt consult a professional fitter for advice.



**WARNING**  
Young children have been strangled by loops in pull cords, chains, tapes and inner cords that operate the product.  
To avoid strangulation and entanglement, keep cords out of the reach of young children. Cords may become wrapped around a child's neck. Move beds, cots and furniture away from window covering cords. Do not tie cords together. Make sure cords do not twist and create a loop.

PERSONS IN CHARGE OF CHILDREN ARE ULTIMATELY RESPONSIBLE FOR FOLLOWING THE SAFETY INSTRUCTIONS PROVIDED BY THE MANUFACTURER AND TO USE ANY SAFETY DEVICE SUPPLIED. The installation can be completed by non-professionals.

### Safety

- Always use a step ladder when working at heights.
- Do not over reach. Always move the step ladder so that you are in a safe working position.
- Do not hold or lean on the track to support your weight.
- Use two people for the installation of longer tracks.
- Take care when using power tools, use of a Residual Current Device (RCD) is recommended.
- Always wear eye protection when drilling.
- Check for hidden pipe runs or cables using a pipe/cable finder.

### Care and Maintenance

Tracks should be wiped clean periodically with a warm damp cloth. The track has been designed to run smoothly for many years, however, the occasional application of silicon polish to the glider channel will ensure continued high performance.

## 7. Adjusting the cord length and fitting the tension pulley

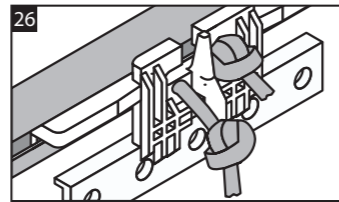

1. Go to the masterslide with the knotted cord ends and pull down on the right hand knot to reduce the cord loop (Fig. 26). To prevent the risk of child strangulation the cord loop must be 1m maximum from the rail and the tension pulley must be fitted.

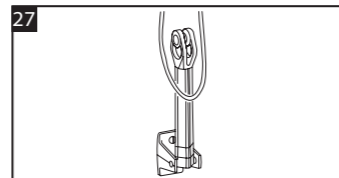

**NOTE: it is the responsibility of the person fitting the rail to ensure that the cord length meets the stated requirements.**

2. Using the two screws supplied, fix the tension pulley at the correct height, directly in line with the pull cord as shown (Fig. 27).

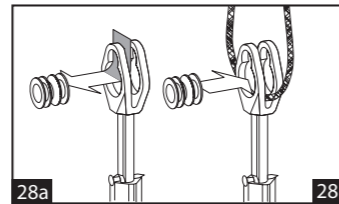

3. Extend the neck of the pulley and secure in higher position using a pin or small nail. Remove the central barrel of the pulley by pulling it down and then out (Fig. 28a).

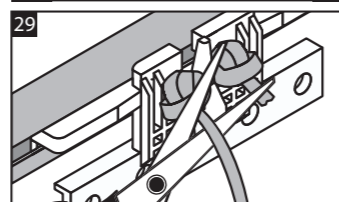

4. Place the cord inside the pulley and replace the barrel ensuring it clicks into place (Fig. 28b).

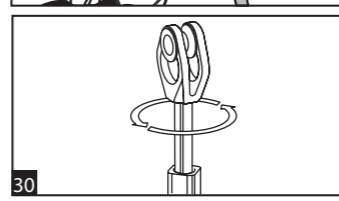

5. Take up the slack of the cord and tie a knot behind the masterslide arm. Remove the pin or nail from the pulley, the cord will now be fully tensioned. If there is insufficient tension in the cord, reduce the cord length by adjusting the knot behind the masterslide arm (Fig. 29). Cut the excess cord in front of the knot. Only when you are sure that the cord length and tension are correct.

6. If the cord becomes twisted, simply rotate the head of the pulley to untwist it (Fig. 30). The track is now ready to accept curtains.

5. Once you have marked the position of the brackets, drill holes and using the appropriate plugs fix the brackets. If you are fitting directly to plaster board ceilings, use the appropriate plaster board fixings, Fig. 20 (not included).

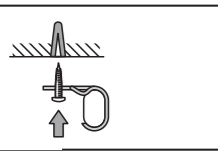

6. You may want to fix a batten to the ceiling or window recess to facilitate the mounting of the rail as shown in Fig. 21. This is the preferred method if you are hanging heavyweight curtains.

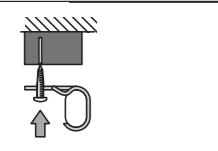

## 5. Fitting master slide overlap and underlap arms

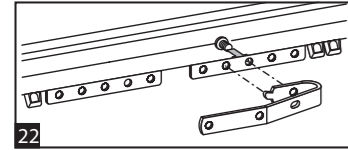

1. The Master Slide arms have four position options and you can choose which side to have the curtain overlap. Remove the small locking screw from the Master slide overlap and reposition the arm as required (Fig. 22).

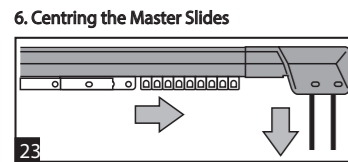

1. Pull the outer draw cord to move the knotted Master Slide to its end of the track (Fig. 23).

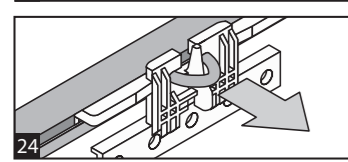

2. Lift up the cord off the peg behind the unknown Master Slide (Fig. 24).

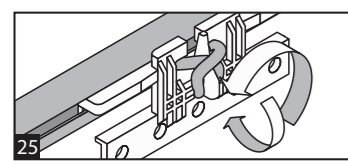

3. Hold both cords taut and move the unknown Master Slide by hand to its end of the track.

4. Pull the outside cord to tighten the loop. Check to ensure the Master Slides are still centred and adjust again if necessary. Lock the cord over the peg as shown in Fig. 25.

### 1. Preparing the window

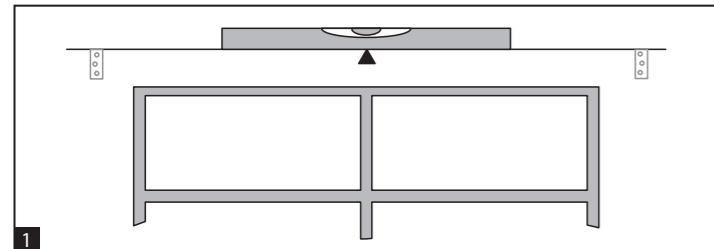

Track must be fitted at least 1.5m from the floor  
1. Use a spirit level to mark the top line of the brackets (Fig.1).

2. Offer the track up to the window and centralise over the window to determine correct length (Fig. 2). Remember to allow sufficient length either side to accommodate the curtains when opened.

For long track lengths you must fit intermediate support brackets at equal intervals along the track length shown in Fig. 3.

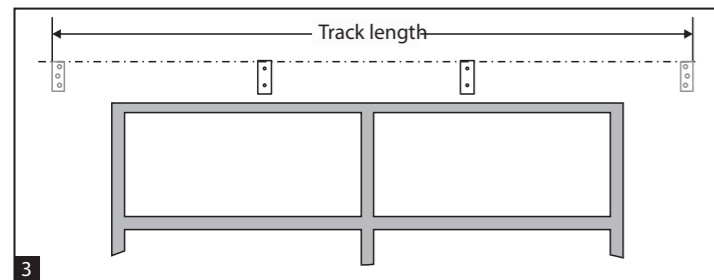
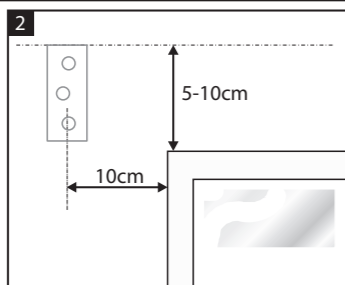

3. The track is adjusted in length by sliding the inner track into or out of the outer track.

### 2. Fitting the track

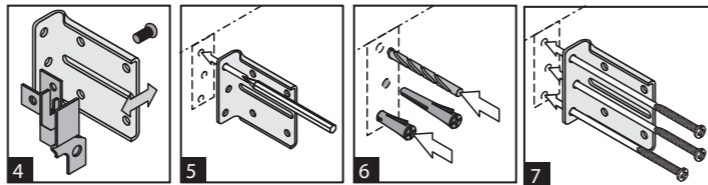

1. It is easier to mount the bracket by removing the mounting clip as shown in Fig. 4.

2. Position the brackets on the wall and mark the holes on the wall (Fig. 5).

3. Drill 2mm pilot hole if mounting on to a wooden batten. If mounting directly on to a masonry or studded wall (Fig. 6), use the appropriate drill size for the wall plug.

Please ensure the correct wall plugs are used to suit your wall type. If in doubt seek advice.

4. Using the correct screws fix the brackets securely (Fig.7). Alternative wall fixings should be used where necessary.

5. Reassemble the bracket mounting clips as shown in Fig. 8.

6. Extend the track to the approximate required length and slot into the end brackets (Fig. 9).

7. You can adjust the position of the track relative to the wall by loosening the small locking screws in the end brackets and then pulling the track out to suit (Fig. 10).

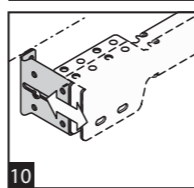
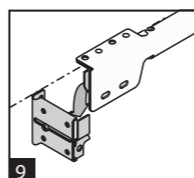
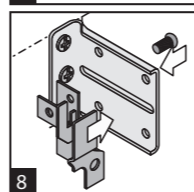

### 3. Fixing intermediate wall brackets

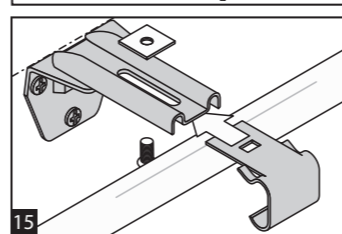
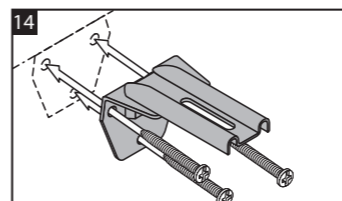
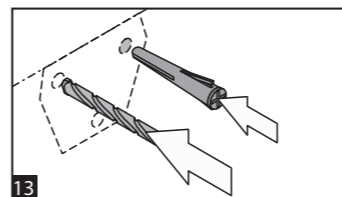
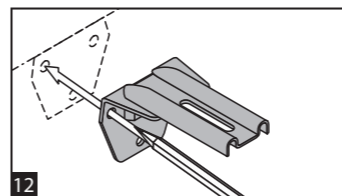
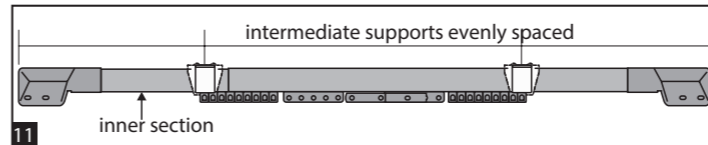

1. With the track in the outer brackets space the intermediate brackets and mark their position (Fig.11).

2. Remove the whole track from the end brackets. Hold the brackets up to the fixing line, mark off the holes for the screws with a pencil (Fig.12).

3. Drill 2mm Ø pilot hole if mounting on to a wooden batten. If mounting directly on to a masonry or studded wall (Fig.13), use the appropriate drill size.

Please ensure the correct wall plugs are used to suit your wall type. If in doubt seek advice.

4. If mounting directly onto a masonry or studded wall insert suitable wall plugs (Fig.13).

5. Fix the brackets securely (Fig.14).

6. Re-fit the track onto the rail end brackets. Fit the intermediate support brackets clips on to the track (Fig. 15).

Use the appropriate clip for the inner and outer rails (the outer has 2 circles & the inner has a circle and square hole).

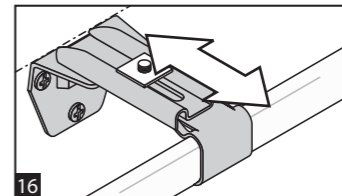

### 4. Ceiling fixing

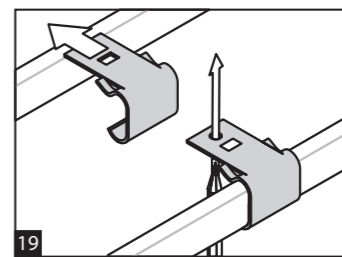
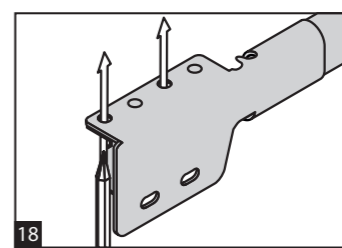
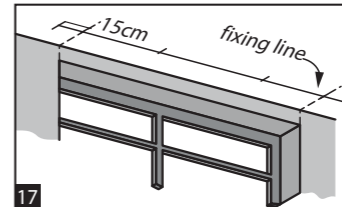

7. If you need to adjust the support brackets, loosen the fastening screws and pull the bracket clip backwards or forwards, Fig. 16.

The track can also be mounted directly to the ceiling or batten on the ceiling. This section describes how to fix the track to the ceiling.

1. To mount the track directly to the ceiling, position track up to the window and centralise over the window to determine correct length, Fig. 17. Remember to allow sufficient length either side to accommodate the curtains when opened and stacked back.

2. For long track lengths you must fit intermediate support brackets at equal intervals along the track length.

3. Position the brackets on the ceiling and mark the holes as shown, Fig. 18.

4. Fit the intermediate support clips onto the track in the fixing position and mark the holes on the ceiling, Fig. 19.